

# Easter Egg Holders

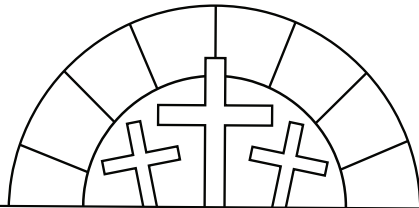

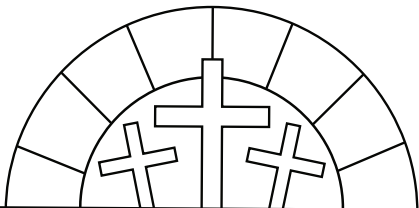

HE IS RISEN



HE IS RISEN

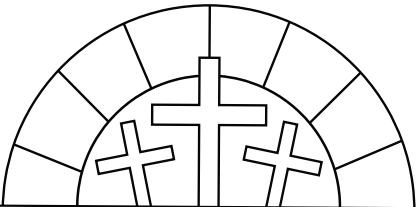

HE IS RISEN

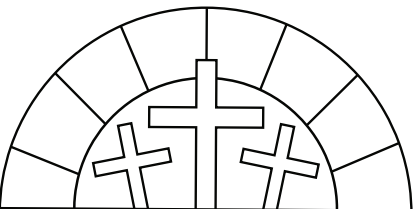

HE IS RISEN

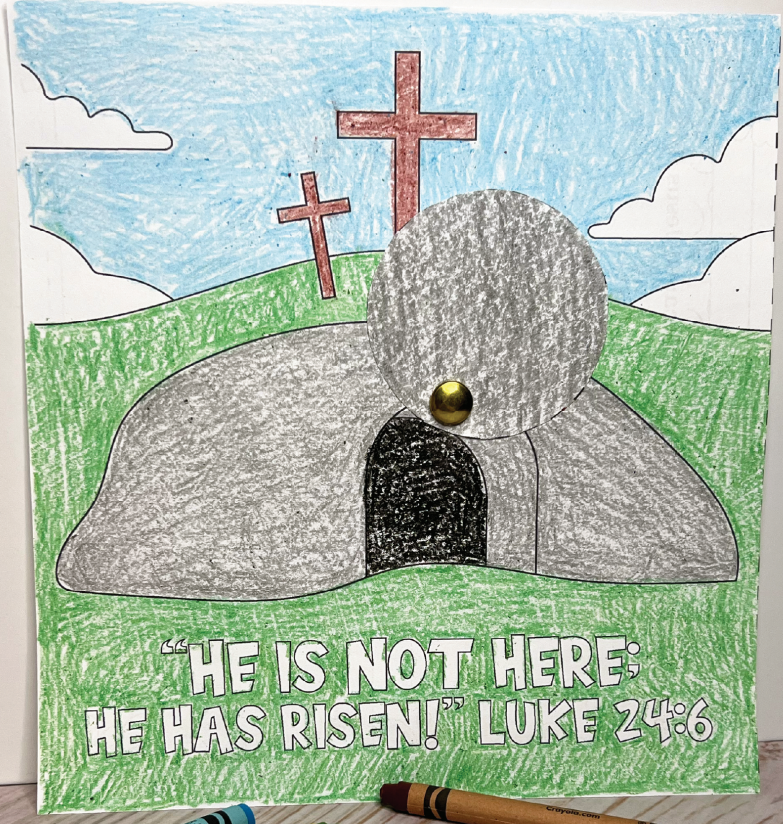

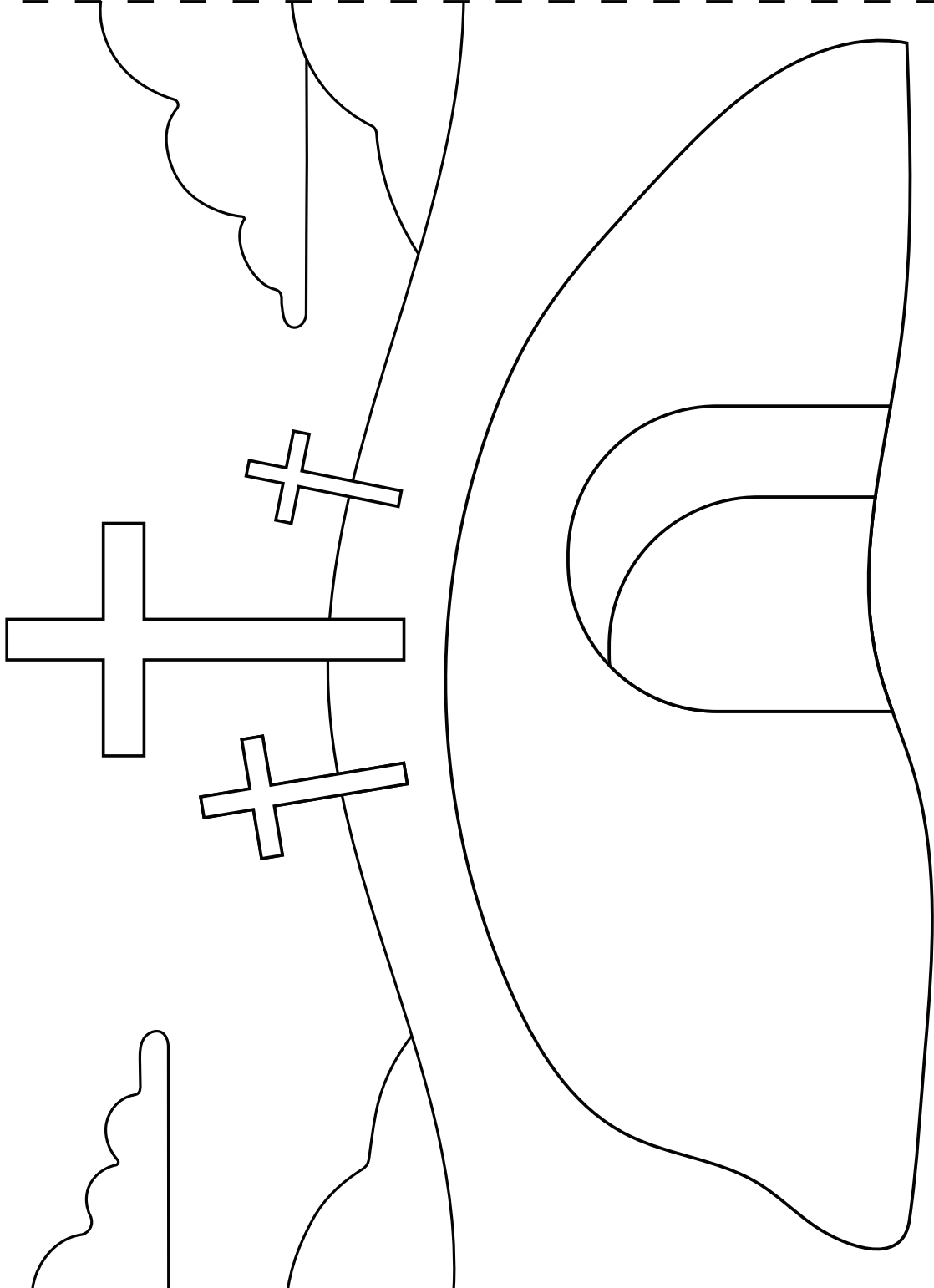

“HE IS NOT HERE,  
HE HAS RISEN!” LUKE 24:6

# Jesus' Death & Resurrection

Free Coloring Pages

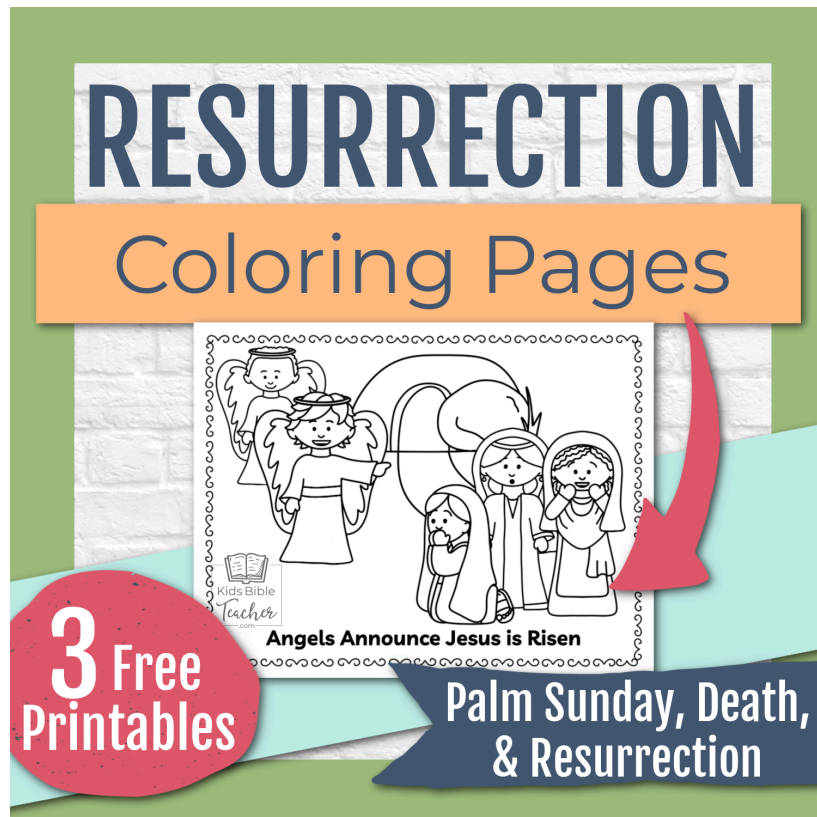

 [Shop Kids Bible Teacher](#)

 [Kids Bible Teacher on Etsy](#)

 [Kids Bible Teacher on Teachers Pay Teachers](#)

# The Triumphal Entry

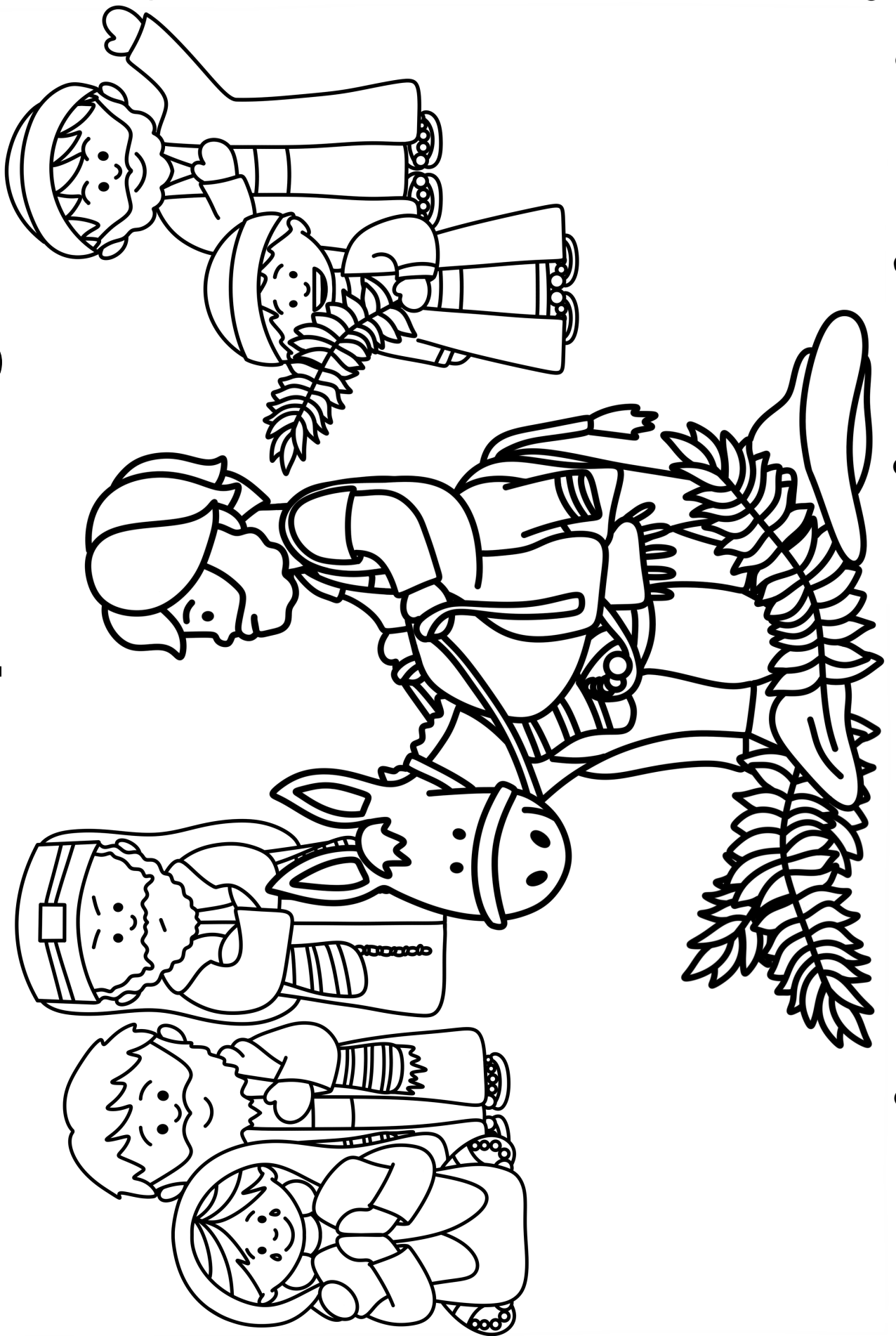

**Jesus is  
Crucified**

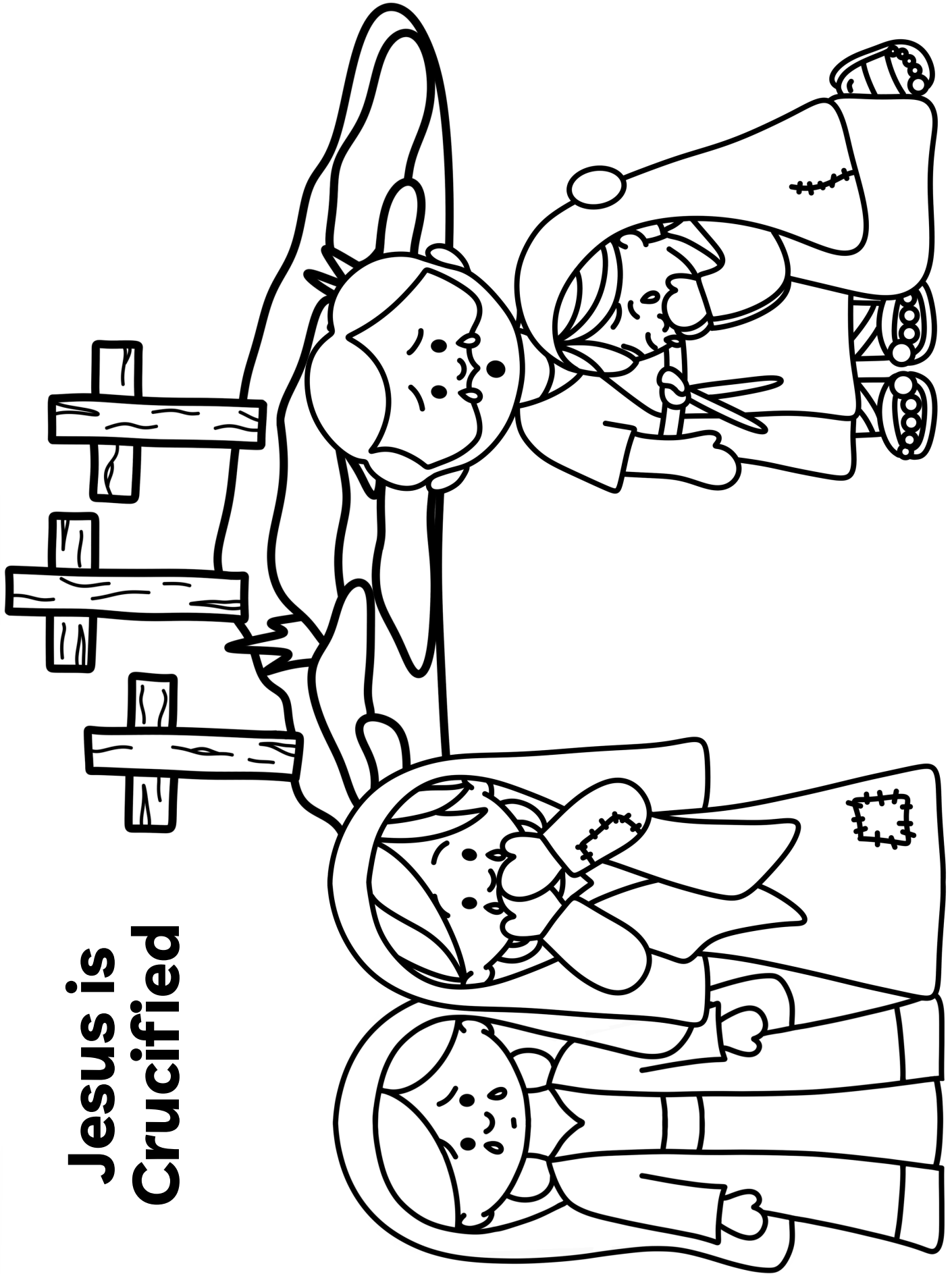

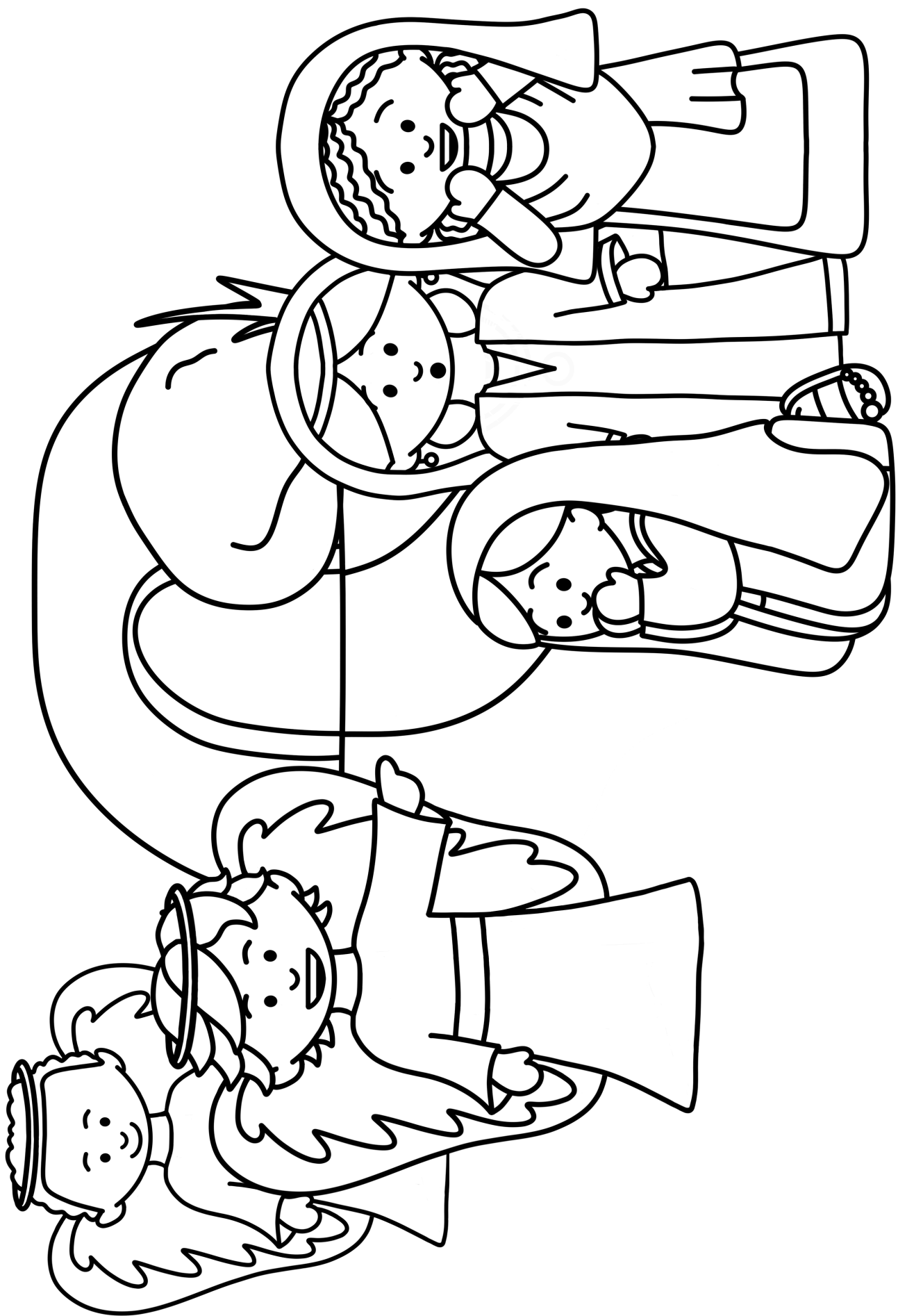

**Angels Announce Jesus is Risen**

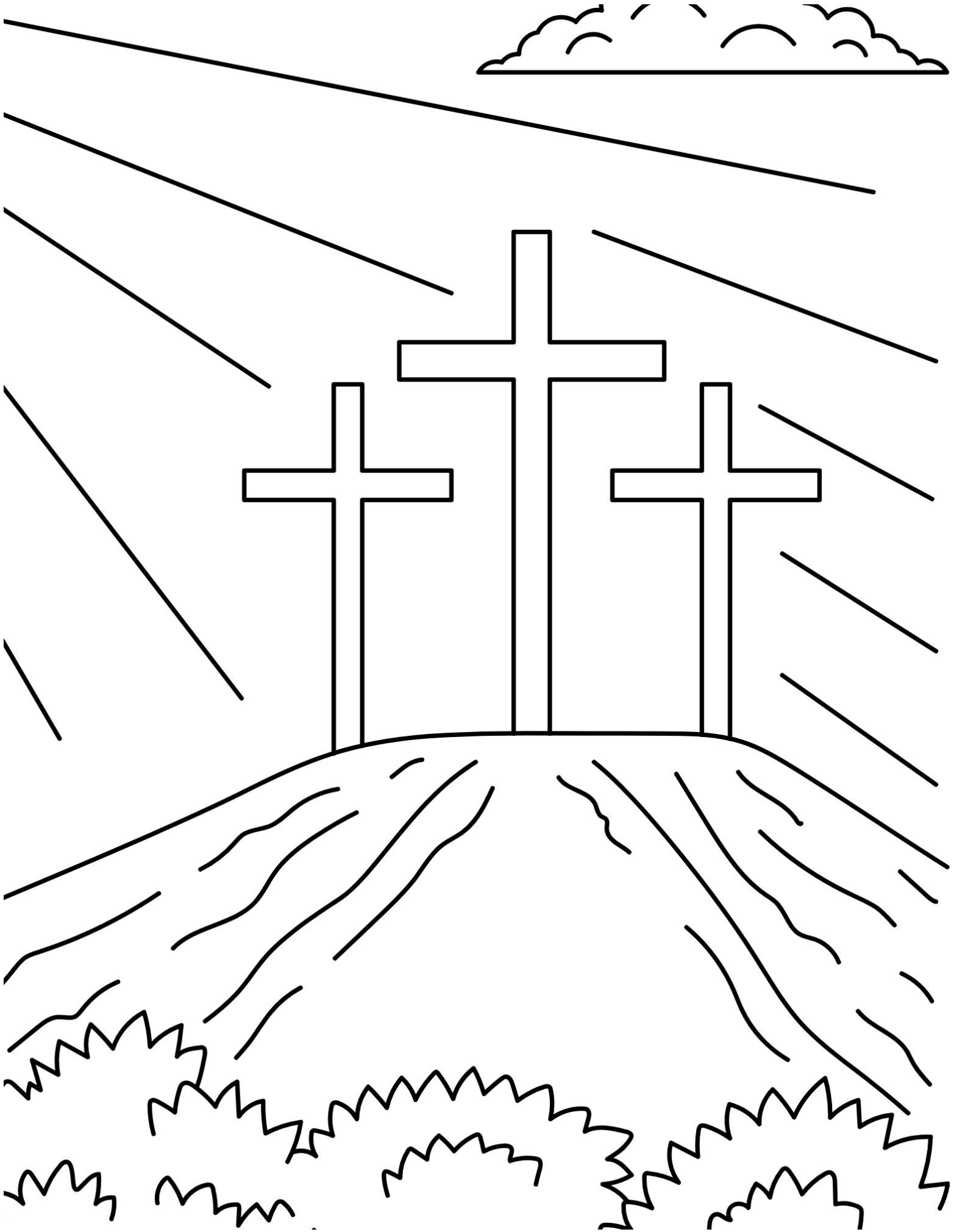

**JESUS IS ALIVE**

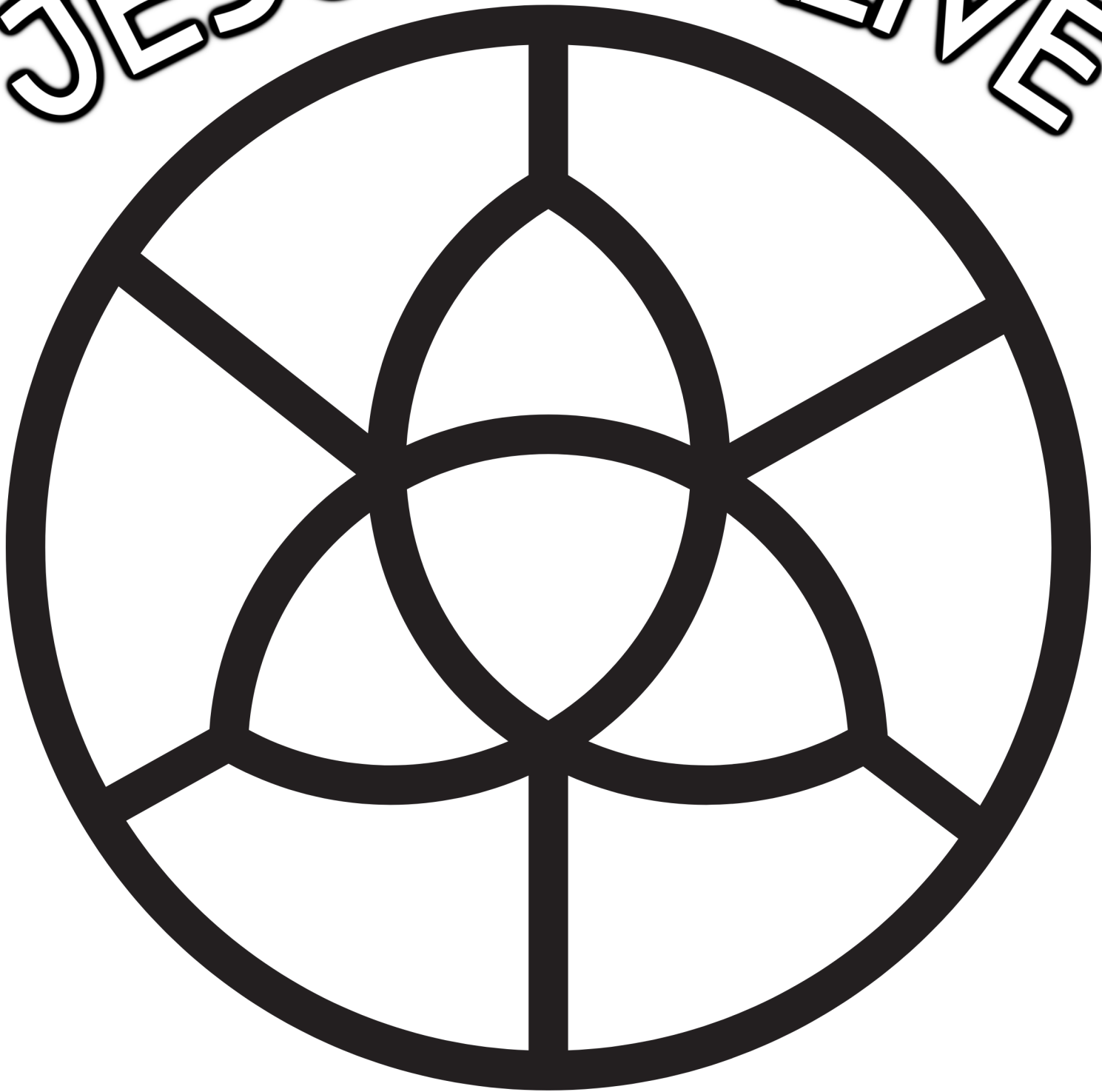

**JESUS SAID TO HER, "I AM THE RESURRECTION AND THE LIFE. WHOEVER BELIEVES IN ME, THOUGH HE DIE, YET SHALL HE LIVE, AND EVERYONE WHO LIVES AND BELIEVES IN ME SHALL NEVER DIE. DO YOU BELIEVE THIS?" JOHN II:25,26**

HE IS RISEN



JESUS SAID TO HER, "I AM THE RESURRECTION AND THE LIFE. WHOEVER BELIEVES IN ME, THOUGH HE DIE, YET SHALL HE LIVE, AND EVERYONE WHO LIVES AND BELIEVES IN ME SHALL NEVER DIE. DO YOU BELIEVE THIS?" JOHN II:25,26

# HE IS RISEN

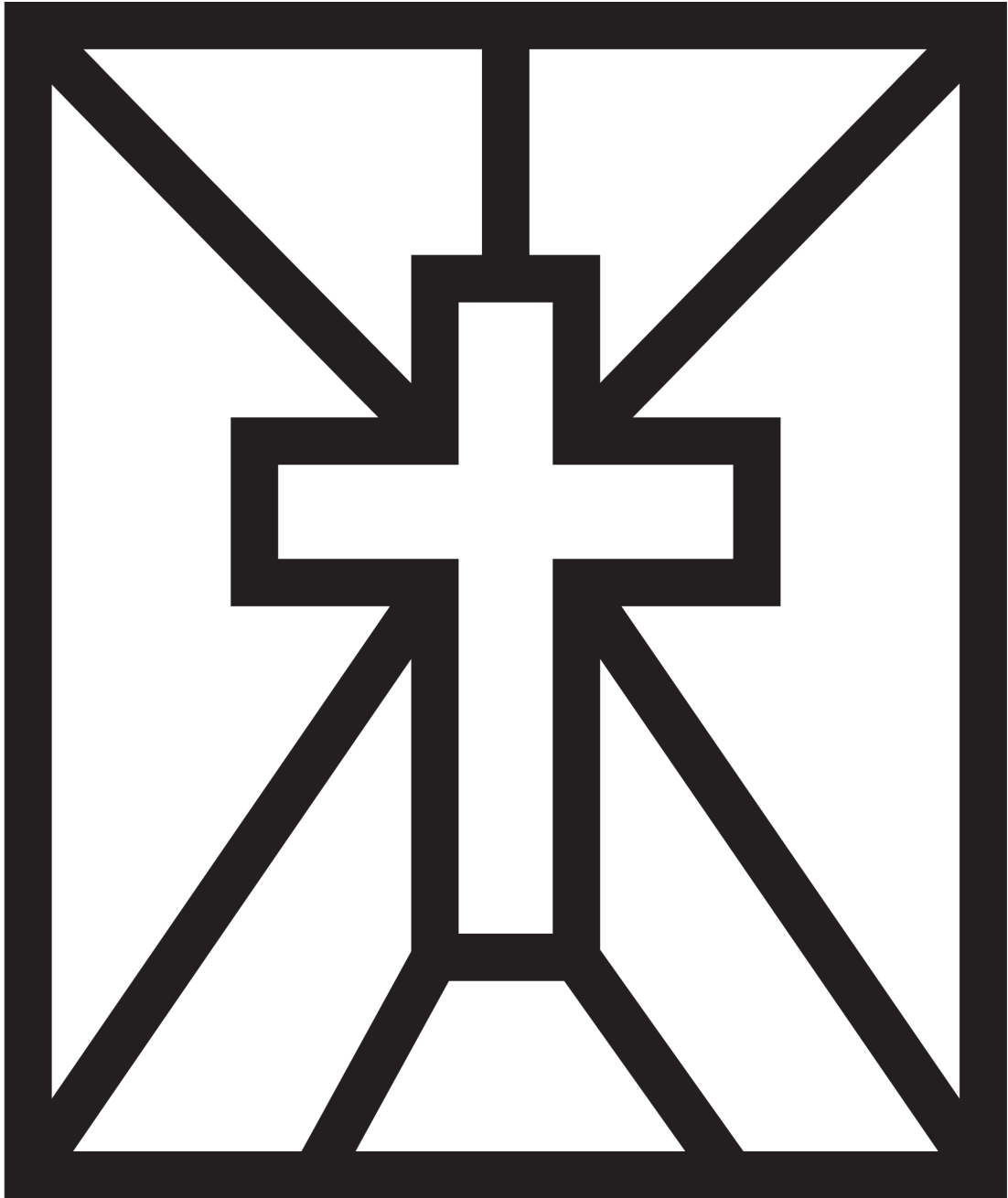

JESUS SAID TO HER, "I AM THE RESURRECTION  
AND THE LIFE. WHOEVER BELIEVES IN ME,  
THOUGH HE DIE, YET SHALL HE LIVE." JOHN 11:25

# Easter Coloring Countdown

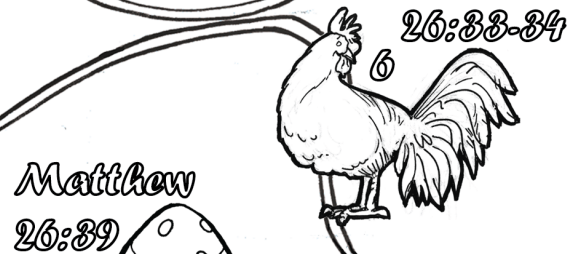

Matthew 28:1-8

# Let's Match

Draw a line to the Easter eggs that match. Then decorate your Easter Eggs!

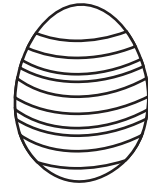
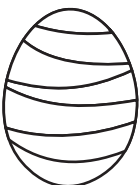
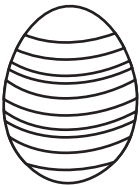
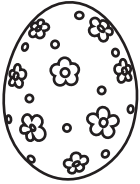

# EASTER STORY WHEEL

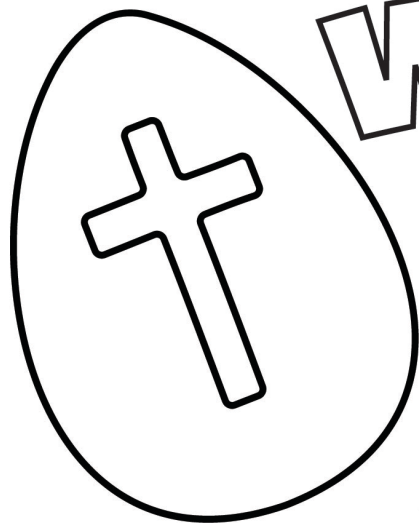

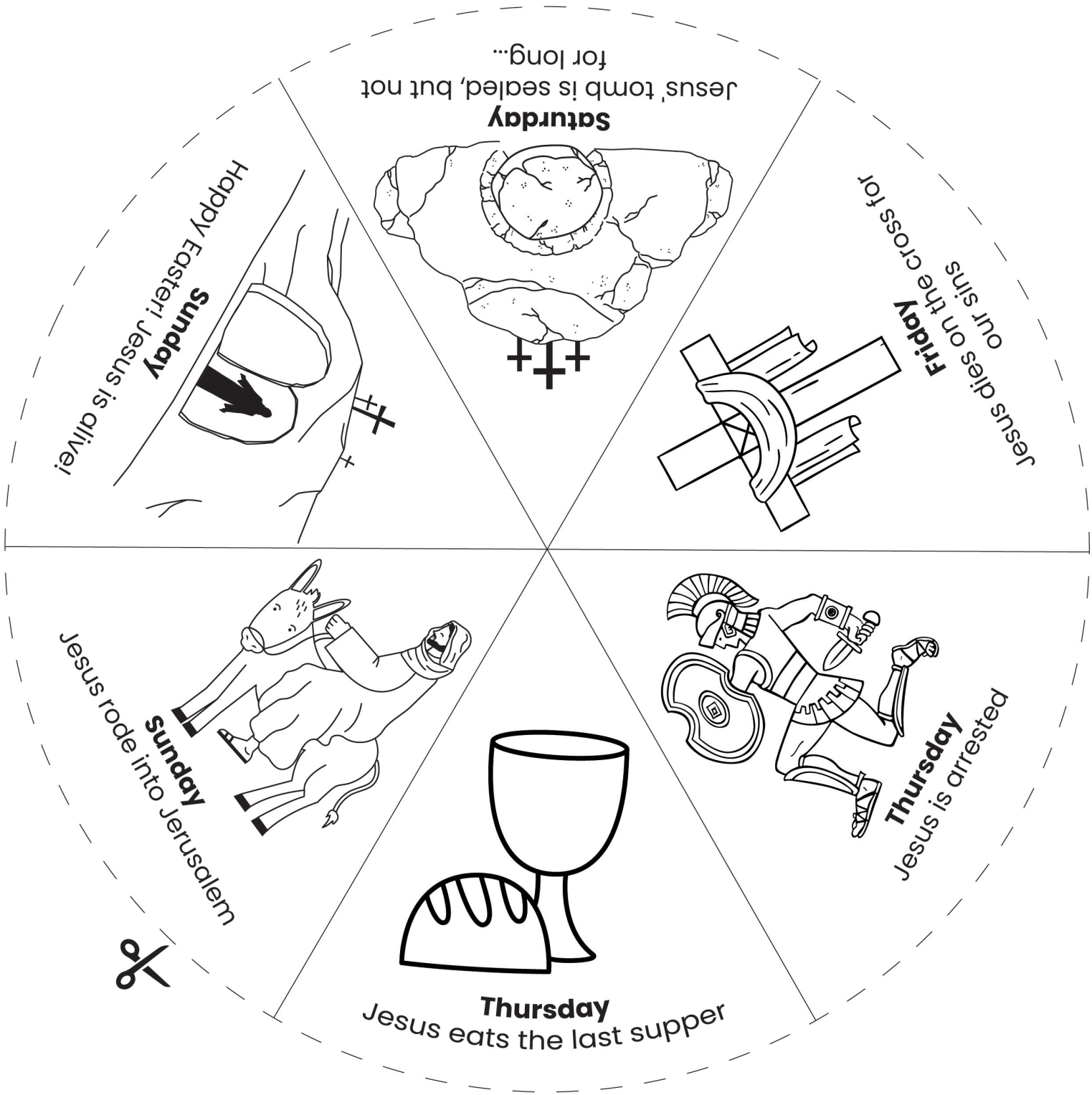

**Sunday**  
Jesus rode into Jerusalem

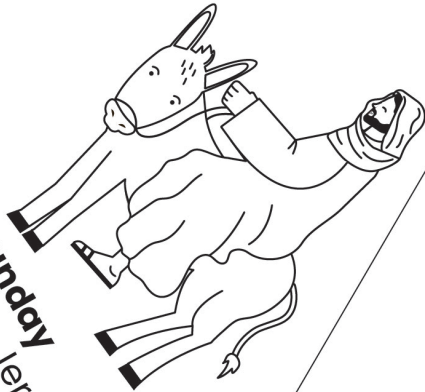

**Sunday**  
Happy Easter! Jesus is alive!



**Thursday**  
Jesus eats the last supper

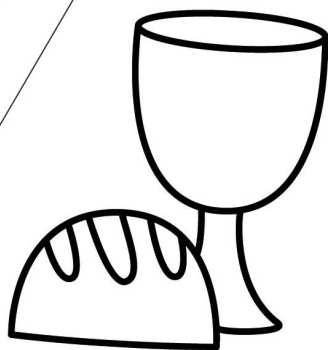

**Thursday**  
Jesus is arrested



**Friday**  
Jesus dies on the cross for our sins

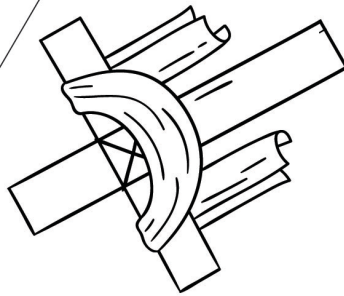

**Saturday**  
Jesus' tomb is sealed, but not for long...

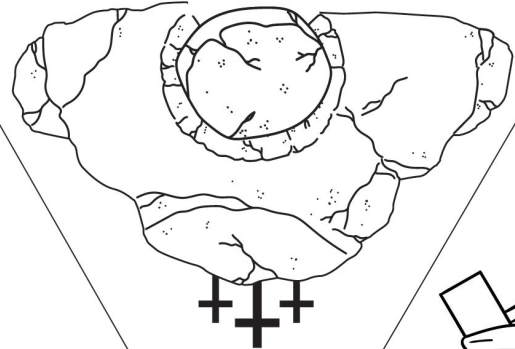

# JESUS' RESURRECTION

## Easter Bookmarks



BUT HE WAS  
WOUNDED FOR OUR  
TRANSGRESSIONS,  
HE WAS BRUISED  
FOR OUR INIQUITIES;  
THE CHASTISEMENT  
FOR OUR PEACE WAS  
UPON HIM,  
AND BY HIS STRIPES  
WE ARE HEALED.

*Isaiah 53:5*

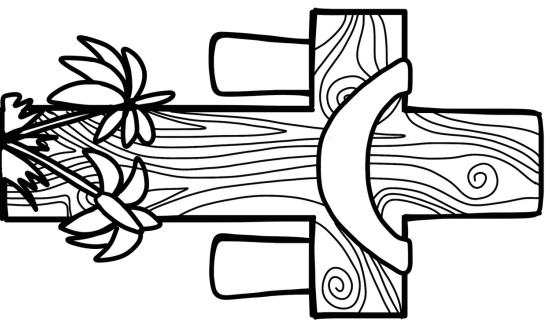

HE IS NOT HERE;  
FOR HE IS RISEN,  
AS HE SAID.

*Matthew 28:6*

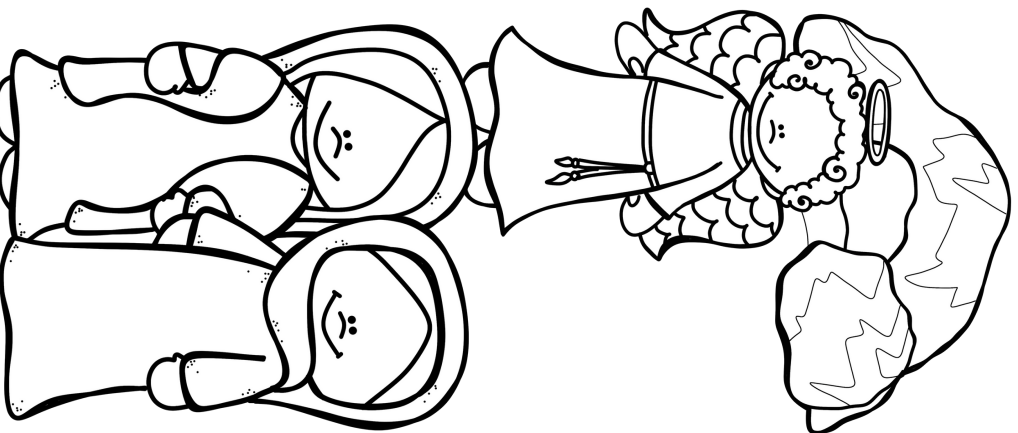

JESUS SAID TO  
HER, "I AM THE  
RESURRECTION  
AND THE LIFE."

*John 11:25*

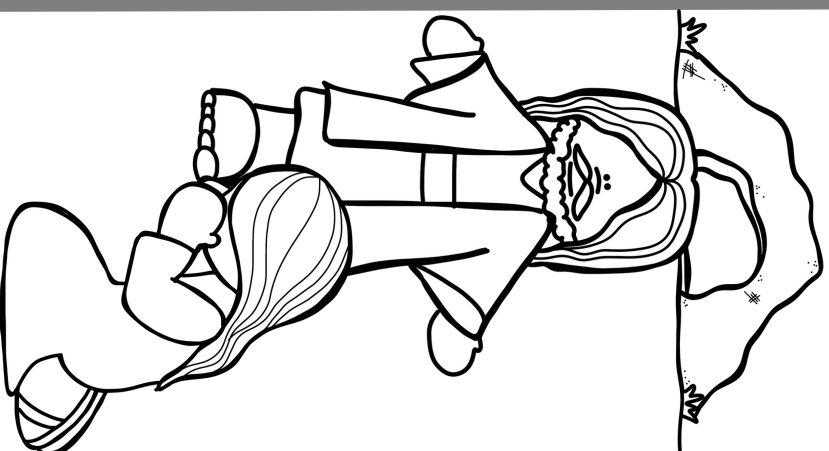

BUT THESE ARE WRITTEN  
THAT YOU MAY BELIEVE  
THAT JESUS IS THE  
CHRIST, THE SON OF GOD,  
AND THAT BELIEVING  
YOU MAY HAVE LIFE IN  
HIS NAME.

*John 20:31*



HE IS  
NOT  
HERE  
HE HAS  
RISEN!

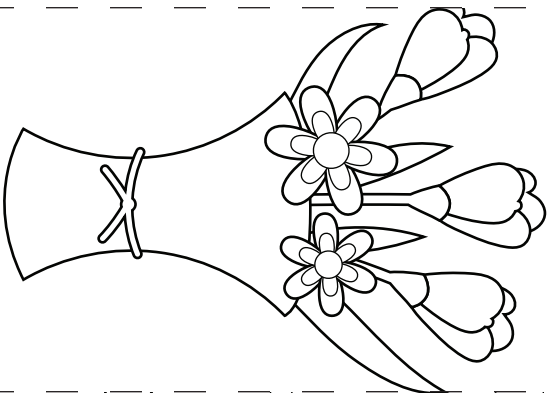

LUKE 24:6

I AM  
THE  
RESURRECTION  
AND

THE LIFE

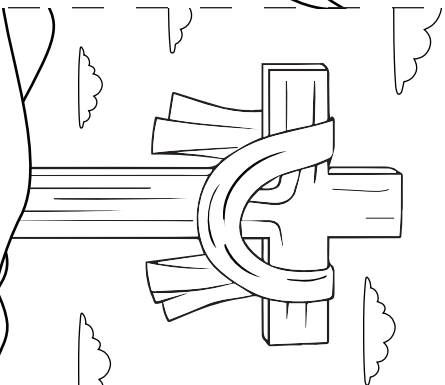

JOHN 11:25

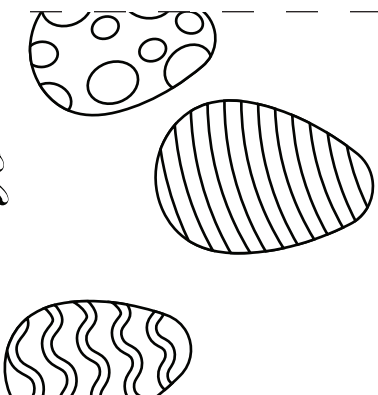

*Happy  
Easter!*

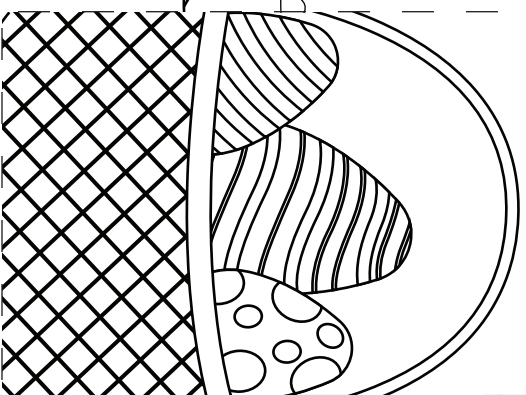

THEREFORE,  
IF ANYONE  
IS IN CHRIST,  
HE IS A NEW  
CREATION



2 CORINTHIANS 5:17

*By His  
wounds  
we are  
healed*

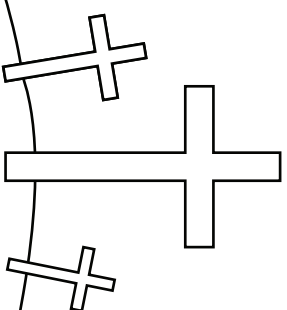

*Isaiah 53:5*

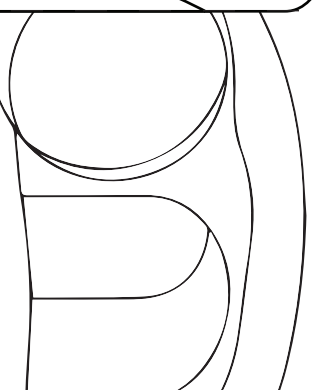

# "HE IS RISEN" EASTER CRAFT

## Bible Craft for Kids



 [Shop Kids Bible Teacher](#)

 [Kids Bible Teacher on Etsy](#)

 [Kids Bible Teacher on Teachers Pay Teachers](#)

# Paper Easter Scene

This printable Easter scene is so cute, so fun to make, and your kids will love individualizing it to make it look exactly the way they want it to look!

## Materials Needed:

- One copy of the two pages for each child, printed in either full color or black and white outline so that kids can color their own.
- A piece of string, yarn, twine, or thin ribbon, about 12 inches (30 cm) per child
- Scissors
- Tape
- Glue
- Crayons, Colored Pencils, or Washable Markers if desired
- One hole punch per many children

## Directions:

- Cut out the large background rectangle with the tree on it along the outer thick black lines. Fold the background in half along the dotted center line so that the pictures are folded inside. Open the background back up.
- Use scissors to carefully cut the two black slits on the bottom. (Adults should do this!)
- Use a hole punch to punch a hole at the two black dots along the top.
- Color the background as desired.
- Take the second page and cut out the grass. Color the grass if desired. Fold the grass along the center dotted line, so that the front side of the grass is on the outside of the fold. Unfold and insert the grass tabs into the slits on the tree rectangle. The back piece will be folded backwards and the grass is folded forwards so that the scene can now stand up.
- Cut out the "He is Risen" rectangle along the outer lines. Then, cut the individual letters apart. DO NOT CUT the dotted lines. Fold each letter along the dotted line so that the letter is on the outside.
- Push one side of the string, yarn, twine, or thin ribbon through the hole on the left side of the background. Tape it to the back. Push the other side of the string through the hole on the right. Pull it to the desired length and tape it to the back.
- Starting with the folded "H" letter, put a small dab of glue at the bottom inside of the fold. "Hang" the "H" on the string, then push the bottom together to secure. Continue with all the letters in order until the banner is complete, reading "He is Risen". You should be able to adjust the letter spacing after all letters are on the string.
- Cut the animals out along the gray circles. (Older kids could do more precise cutting, if desired.) Tape or glue the flowers and animals where desired in the scene.



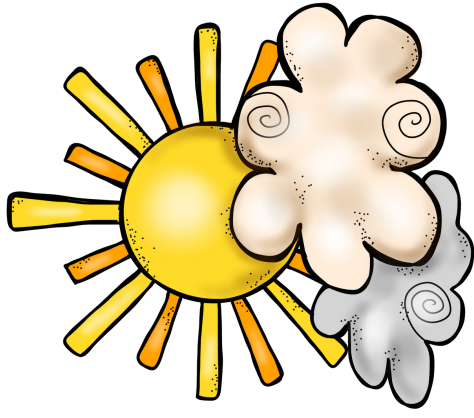

© 2021 Kids Bible Teacher.com | Graphics by Edu-Clips.com





# Jesus is Risen (Easter) Word-For-Word Bible Verse Search & Find



👉 Hint: Print "even pages only" for student handouts without the answers.

Matthew 28:6 NIV

He is not here; he has risen, just as he said. Come and see  
the place where he lay.

---

P D J Q W B U F N O  
G L S C H X C D Y M  
S A A H E H H E P K  
Q Y I C R I S E N I  
A N D O E G S H O Z  
L X T M L N E G T Q  
J I A E U L P H M U  
N Y G A J T H E A A  
F U R Z W U H R K S  
Z Y K B R X S E E C  
Q Q W M B A C T V G

---

Matthew 28:6 NIV

He is not here; he has risen, just as he said. Come and see the place where he lay.



1 Corinthians 6:14 NIV

By his power God raised the Lord from the dead, and he  
will raise us also.

---

V I I U K M M A J Y  
B I R C D G T I F Z  
P L Q W N G P F I C  
R Z X H F R O M S Z  
G A W I L L W D L Z  
R A I S E O E E V J  
M N L S D B R R C B  
I D U S E U D D B Y  
Q V N T O D E A D Q  
Z E S H E D K S M H  
E T H E E J B L F B

---

1 Corinthians 6:14 NIV

By his power God raised the Lord from the dead, and he  
will raise us also.

